



A-UNIQUE

# ASIA UNIQUE LED LIGHTING CO., LTD

## Dual Watt & 4CCT Fire Rated Downlight

## Versatile V Series

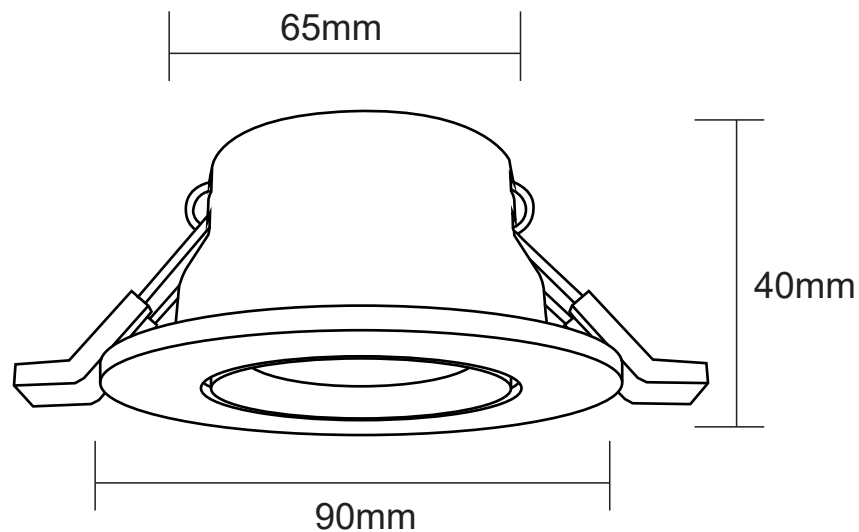
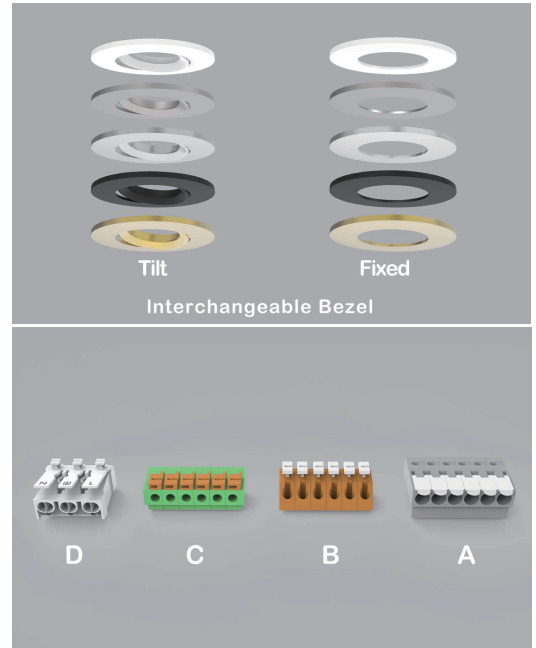
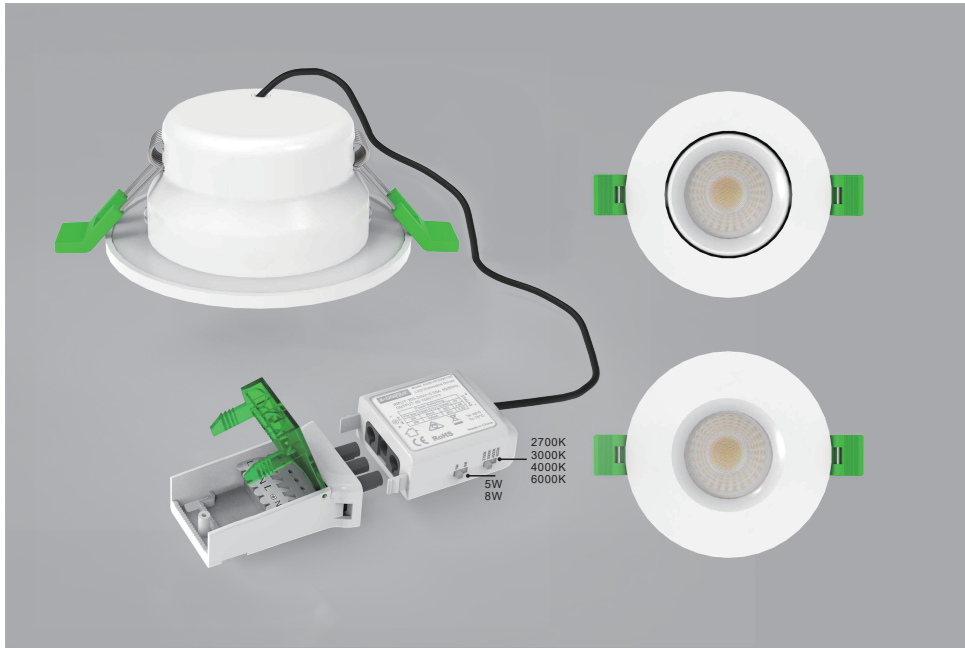



## General Features:

- Dual wattage control: 5W / 8W selectable
- 4CCT: 2700K 3000K 4000K 5000K selectable via switch
- Interchangeable bezel: Can be white / black / polished silver /brushed chrome
- Flicker Free Driver: For better visual comfort
- Triac Dimmable,Compatible to most branded dimmers, and C-bus2 system
- Fire Rated
- IP65 rated for the fron
- UKCA, SAA, C-tick, CE and RoHS approved
- **3years warranty**

## Technical Specifications

Model No.	AU35-DL0508F-4C (Fixed versòn) / AU35-DL0508G-4C (Gimble version )	
Dimension(mm)	Ø90*H40	
Cutout(mm)	65	
Wattage(w)	5W/8W selectable	
Input Voltage(v)	AC200~240V	
Light Source	SMD	
SDCM	<6	
4 CCT(K)	2700K- 3000K-4000K-5000K	
Luminious Flux (lm)±5%	460-540lm(5W), 720-840lm(8W)	
CRI	>80Ra	
Beam Angle(°)	38° / 60°	
Driver option	Triac Dimming	
Fire Rated	Yes	
Protection Class	Class I	
Degree of protection(IP)	IP65	
Material	Housing	Iron
	Diffuser	PC
Color	Bezel	white / black /Polished silver / gold / brushed chrome
	Housing	White
L70	>54000Hrs	
Operation Temp.(°C)	-20~ 45°C	
Installation	Recessed Mount	
Certificates	UKCA, CE, Rohs, SAA & C-tick	
Warranty	3 Years	

## Packing information

Model Number	Weight/Luminaire (kg)	QTY/BOX (pcs)	Inner Box Size (mm)	Weight/Box (kg)	QTY/CTN (pcs)	Carton Size (cm)	Weight/CTN (kg)	QTY/20GP (PCS)	QTY/40GP (PCS)	QTY/40HQ (PCS)
AU35-DL0508F-4C Or AU35-DL0508G-4C	0.25	1	120*120*75	0.30	48	50*38*33	14.5	17760	37008	46608

# Installation Instructions

1. Open a hole according to the cutout size of led downlight.

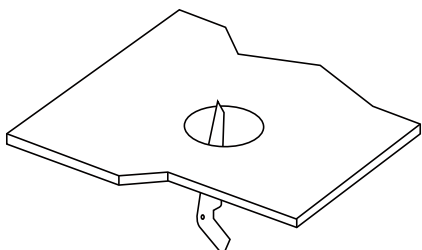

2. Use screw-driver to open the driver terminal cover, feed the main AC wire L. N. in terminal block respectively, then fix the cover back.

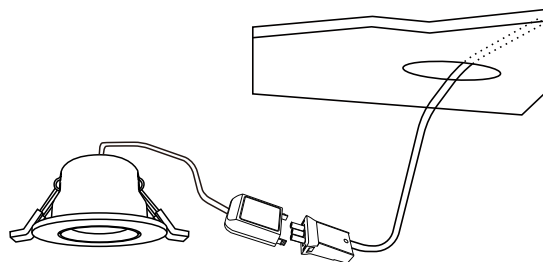

3. Connect the downlight with driver, hold back the spring clip then push the downlight into the hole.

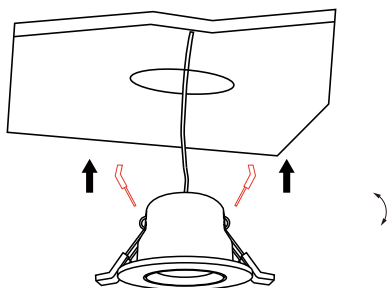

4. Make sure the downlight fixed tightly in ceiling, turn on the power.

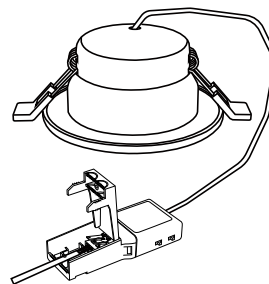

## Please Note :

- \* Turn off and isolate the electrical supply before connecting this fitting to the building wires.
- \* Must be installed, or connected by licenced electrician.
- \* The Luminaires are intended for indoor use only.

## Applications :

- Hospitality applications
- Residential applications
- Office Buildings
- Hotels
- Shopping Malls
- Supermarkets